

tuozì  [®]
by Movelar

VENIT

BARBECUES



www.tuozì.pt

movelar [®]

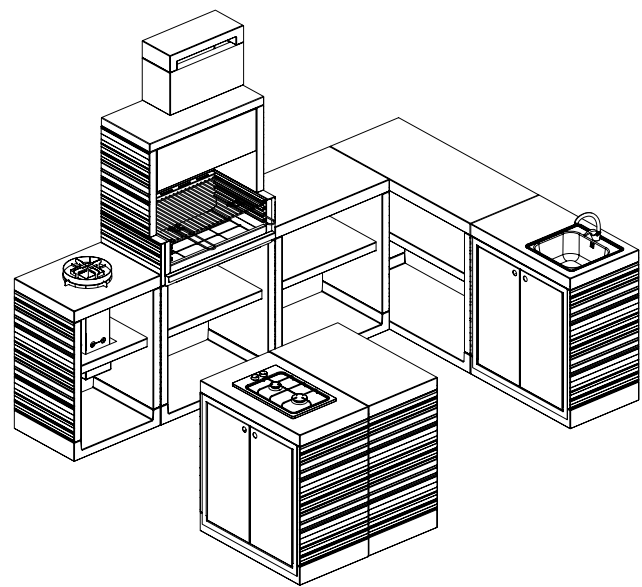

sunny living 



SERIE
VENIT
wood & charcoal

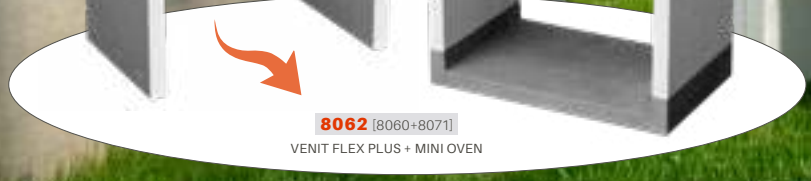

8071/1 PLAN/MINI OVEN SHORT
43 x 30 x 18,7hcm * **16Kg**

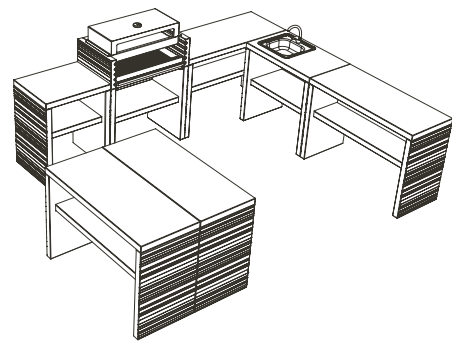

[8061+8011/1]
T00066
PACK 4 VENIT
FIREWOOD & CHARCOAL

- MAX. LOAD **13DM3**
- 156 x 47 x 95h cm
- 64 x 38 cm *
- 72,5 x 45,5 cm *
- 397Kg

- White and Grey Concrete
- Wood and Charcoal
- Metalic grill with 64 x 38cm
- Textured concrete side parts
- Metallic fire protection (according to EN norms)
- Metal rack support for charcoal burning
- Drawer for cleaning ashes
- Concrete lower stand
- Stainless steel sink + valve
- Chromed faucet
- Supplied with silicone for assembly

Packing dimensions+
85 x 65 x 130h cm
* package with 2 bbq on individual pallet





grace and beauty



4413
VENIT FLEX PACK2
FIREWOOD & CHARCOAL

MAX. LOAD **7,75DM3**

White and grey concrete
Metalic grill Niqueled

170 x 47 x 185h cm

46,5 x 37 cm *

54 x 45,5 cm

520 Kg 6 px

Packing dimensions+
80 x 60 x 127h cm
120 x 80 x 100h cm
+ package with 2 bbq
on individual pallet
units/truck 57

- White and grey concrete
- No paint required
- Use of firewood and charcoal
- Metal grill with 46,5 x 37 cm
- Aluminized metal brazier painted with drawer to collect ashes
- Textured side plate
- Bottom shelf in plain white concrete
- Chimney in white and grey concrete (possibility of extension)
- Countertop module with stainless steel sink PLAN 1 ref. 8012



4410
VENIT FLEX HOTTE
CHARCOAL

MAX. LOAD **9,4DM3**

White and grey concrete
Metalic grill

60 x 47 x 185h cm

51 x 41 cm *

54,5 x 45,5 cm

320 Kg 6 px

Packing dimensions
80 x 60 x 115h cm
+ package with 2 bbq
on individual pallet
units/truck 66

4411
VENIT FLEX HOTTE
FIREWOOD & CHARCOAL

MAX. LOAD **7,75DM3**

White and grey concrete
Metalic grill

60 x 47 x 185h cm

46,5 x 37 cm *

54,5 x 45,5 cm

350 Kg 6 px

Packing dimensions
80 x 60 x 115h cm
+ package with 2 bbq
on individual pallet
units/truck 66

8065
VENIT FLEX PLUS HOTTE
CHARCOAL

MAX. LOAD **13DM3**

White and grey concrete
Metalic grill

78 x 47 x 185h cm

69 x 42 cm *

69,5 x 42 x 10hcm

396 Kg 8 px

Packing dimensions
80 x 60 x 150h cm
+ package with 2 bbq
on individual pallet
units/truck 57

8066
VENIT FLEX PLUS HOTTE
FIREWOOD & CHARCOAL

MAX. LOAD **13DM3**

White and grey concrete
Metalic grill

78 x 47 x 185h cm

64 x 38 cm *

69,5 x 42 x 26hcm

405 Kg 8 px

Packing dimensions
80 x 60 x 150h cm
+ package with 2 bbq
on individual pallet
units/truck 57

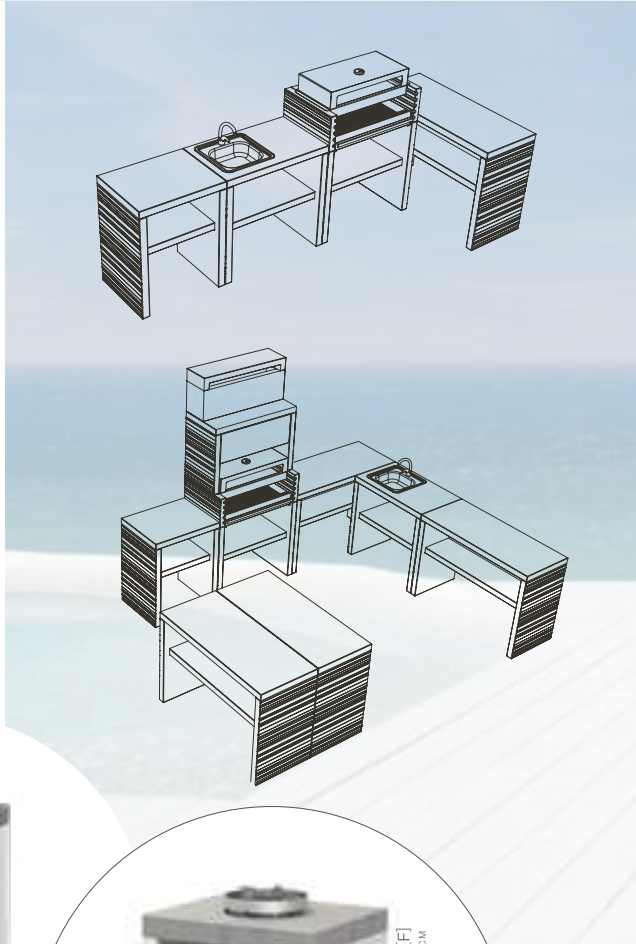

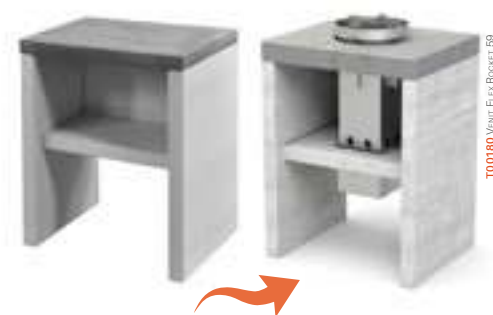

PLAN/VENIT MODULES SYSTEM

COMPATIBLE with all **PLAN** and **VENIT** Barbecues



8010 PLAN/VENIT 0



White and grey concrete
Textured concrete side
parts. Concrete lower
shelf

 59 x 47 x 77h cm
 120 Kg

 Packing dimensions+
80 x 60 x 100h cm
+ package with 2 bbsq
on individual pallet
units/truck 132

8011 PLAN/VENIT 1



White and grey concrete
Textured concrete side
parts. Concrete lower
shelf

 78 x 47 x 77h cm
 150 Kg

 Packing dimensions+
80 x 60 x 100h cm
+ package with 2 bbsq
on individual pallet
units/truck 132

8012 PLAN/VENIT 2



White and grey concrete
Textured concrete side
parts. Concrete lower
shelf

 110 x 47 x 77h cm
 199 Kg

 Packing dimensions+
120 x 80 x 100h cm
+ package with 2 bbsq
on individual pallet
units/truck 66

8011/1 . 8012/1 PLAN/VENIT 1 PLAN/VENIT SINK/TAP

White and grey concrete
Textured concrete side
parts. Concrete lower
shelf

 78 x 47 x 77h cm
 110 x 47 x 77h cm
 150/199 Kg

 Packing dimensions+
85 x 65 x 130h cm
+ package with 2 bbsq
on individual pallet
units/truck 112

White & Grey Concrete .
Textured concrete . .
side parts .
Chromed tap .
Stainless steel sink .
Concrete lower stand .
Compatible with all
Plan/Venit barbecues .



design
new concept

sunny living 

Plan/Venit system

SOME CONFIGURATIONS

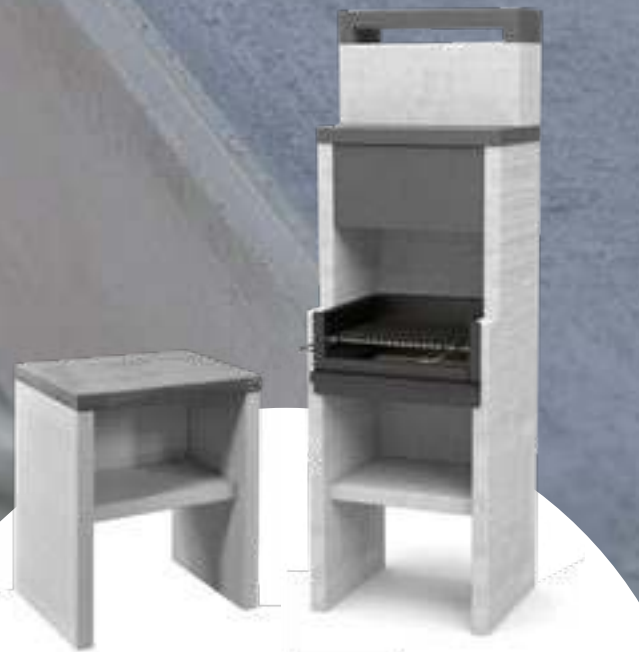
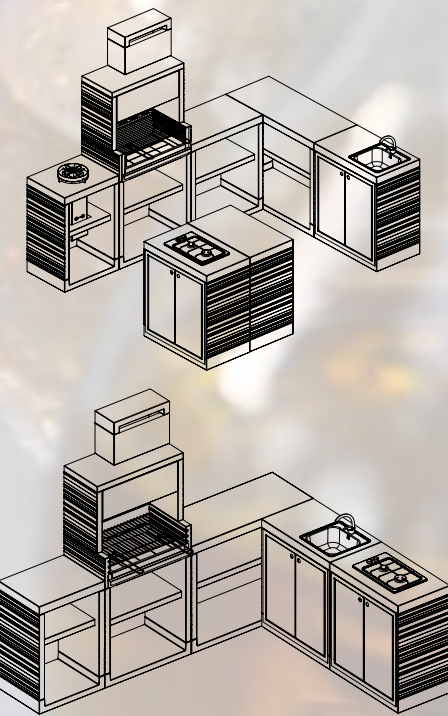

T00179
DUPLA PORTA
PLAN/VENIT 78 [F]
4 Kg



T00183
VENIT FLEX HOTTE [F]
CHARCOAL

 MAX. LOAD 9,4DM3

White and grey concrete
Metalic grill

 60 x 47 x 197h cm

 51 x 41 cm *



 54,5 x 45,5 cm

 394 Kg  6 px

 Packing dimensions
80 x 60 x 115h cm
* package with 2 bbq
on individual pallet units/truck 66



T00154
VENIT FLEX HOTTE [F]
FIREWOOD & CHARCOAL



  MAX. LOAD 7,75DM3

White and grey concrete
Metalic grill

 60 x 47 x 197h cm

 46,5 x 37 cm *

 54,5 x 45,5 cm

 424 Kg  6 px

 Packing dimensions
80 x 60 x 115h cm
* package with 2 bbq
on individual pallet units/truck 66



T00132
VENIT FLEX PLUS HOTTE [F]
CHARCOAL

 MAX. LOAD 13DM3

White and grey concrete
Metalic grill

 78 x 47 x 197h cm

 69 x 42 cm *

 72,5 x 45,5 x 11h cm

 490Kg  8 px

 Packing dimensions
80 x 60 x 150h cm
* package with 2 bbq
on individual pallet units/truck 67



T00131
VENIT FLEX PLUS HOTTE [F]
FIREWOOD & CHARCOAL

  MAX. LOAD 13DM3

White and grey concrete
Metalic grill

 78 x 47 x 197h cm

 64 x 38 cm *

 72,5 x 45,5 x 11h cm

 499 Kg  8 px

 Packing dimensions
80 x 60 x 150h cm
* package with 2 bbq
on individual pallet units/truck 67



T00126 / T00136*
PLAN/VENIT 78 [F]

White and grey concrete
Textured concrete side
parts. Concrete lower
shelf

 78 x 47 x 88h cm

 110 x 47 x 88h cm

 197/265 Kg

 Packing dimensions+
80 x 60 x 100h cm
* package with 2 bbq
on individual pallet units/truck 132



T00125 / T00318*
PLAN/VENIT 78 [F]

White and grey concrete
Textured concrete side
parts. Concrete lower
shelf

 78 x 47 x 88h cm

 110 x 47 x 88h cm

 180 Kg

 Packing dimensions+
80 x 60 x 100h cm
* package with 2 bbq
on individual pallet units/truck 132

footer
PLAN/VENIT [F]





T00176
PLAN/VENIT 59

 59 x 47 x 11h cm

 37 kg

T00177
PLAN/VENIT 78

 78 x 47 x 11h cm

 47 kg

T00323
PLAN/VENIT 100

 100 x 47 x 11h cm

 60 kg

T00178
PLAN/VENIT 110

 110 x 47 x 11h cm

 66 kg



T00179
DUPLA PORTA
PLAN/VENIT 78 [F]
4 Kg



T00134
PLAN/VENIT 78 [F]
GAS

White and grey concrete
Textured concrete side parts.
Concrete lower shelf.
2 COOKING ZONE:
. 1 double ring burner
(3,00 kW). 1 auxiliary burner
(1,00 kW)

78 x 47 x 93h cm
188 Kg

Packing dimensions+
80 x 60 x 100h cm
units/truck 132
+ package with 2 boxes
on individual pallet



T00175
PLAN/VENIT 78 [F]
GAS/DOORS

White and grey concrete
Textured concrete side parts.
Concrete lower shelf. Alumi-
nized steel doors with black
powder coating
2 cooking zone: 1 double ring
burner (3,00 kW). 1 auxiliary
burner (1,00 kW)

78 x 47 x 93h cm
196 Kg

Packing dimensions+
95 x 70 x 100h cm
units/truck 132
+ package with 2 boxes
on individual pallet



T00259
PLAN/VENIT 78 [F]
GRILLER

White and grey concrete
Textured concrete side parts.
Concrete lower shelf. Alumi-
nized steel doors with black
powder coating. Stainless
steel surface. Cast iron grid.
1 electric resistance . Max.
nominal power: 2400 W

78 x 47 x 93h cm
196 Kg

Packing dimensions+
95 x 70 x 100h cm
units/truck 132
+ package with 2 boxes
on individual pallet



PLAN/VENIT 78 [F]
GRILLER + DOORS

White and grey concrete
Textured concrete side parts.
Concrete lower shelf. Alumi-
nized steel doors with black
powder coating. Stainless
steel surface. Cast iron grid.
1 electric resistance . Max.
nominal power: 2400 W

78 x 47 x 93h cm
196 Kg

Packing dimensions+
95 x 70 x 100h cm
units/truck 132
+ package with 2 boxes
on individual pallet

T00211 CONCRETE BUILT IN STRUCTURE 78 [F]

Teka BUILT IN HOBS
POSSIBILITIES



EFX 30.1 TEPPANYAKI

. 30 cm Modular hob Teppanyaki . Stainless steel surface . Metallic looking frontal knob . Overheating cut-off system . Efficiency value more than 90% . High temperature resistance surface (AISI 304) max 270C. Thermostat for a constant cooking temperature control . Easy cleaning . Max. nominal power: 2400 W



EFX 30.1 FRYER

. 30 cm Modular Fryer . Fryer . Stainless steel surface . Metallic looking frontal knob . Overheating cut-off system . Thermostat for a constant oil temperature control . 2 electric resistance . Max. nominal power: 2300 W



CGW LUX 30.1 2G

. 30 cm Modular gas on glass hob . Gas typology : LPG (butane/propane) . New professional look . Cast iron grid . Auto-ignition . Auto-lock safety device . Metallic and glossy black looking . frontal knob . 2 cooking zones: 1 fast burner (2.8 kW) ; 1 auxiliary burner (1 kW)



EFX 30.1 2G AI AL CI

. 30 cm Modular gas hob Gas typology: LPG (butane / propane) . Stainless steel surface . Cast iron grid . Auto-ignition . Auto-lock safety device . High Efficiency burners . Metallic looking frontal knob . 2 cooking zone: 1 double ring burner (3,00 kW) . 1 auxiliary burner (1,00 kW)



TR 3220

. 30 cm Modular vitroc-ramic hob . Touch control panel . Bevelled glass . Security blocking . Burst of cooking function . Cooking time programmer . Independent programmer of each cooking zone . Residual heat indicator . 2 cooking zones: 1 double high light (120/180 mm Ø) . 1 high light (145 mm Ø) . Max. nominal power: 2900 W



EFX 30.1 BBQ GRILL

. 30 cm Modular BBQ/GRILL Barbecue . Stainless steel surface . Cast iron grid . Metallic looking frontal knob . Overheating cut-off system . 1 electric resistance . Max.nominal power: 2400 W

design
make your own
outdoor kitchen

new concept

sunny living

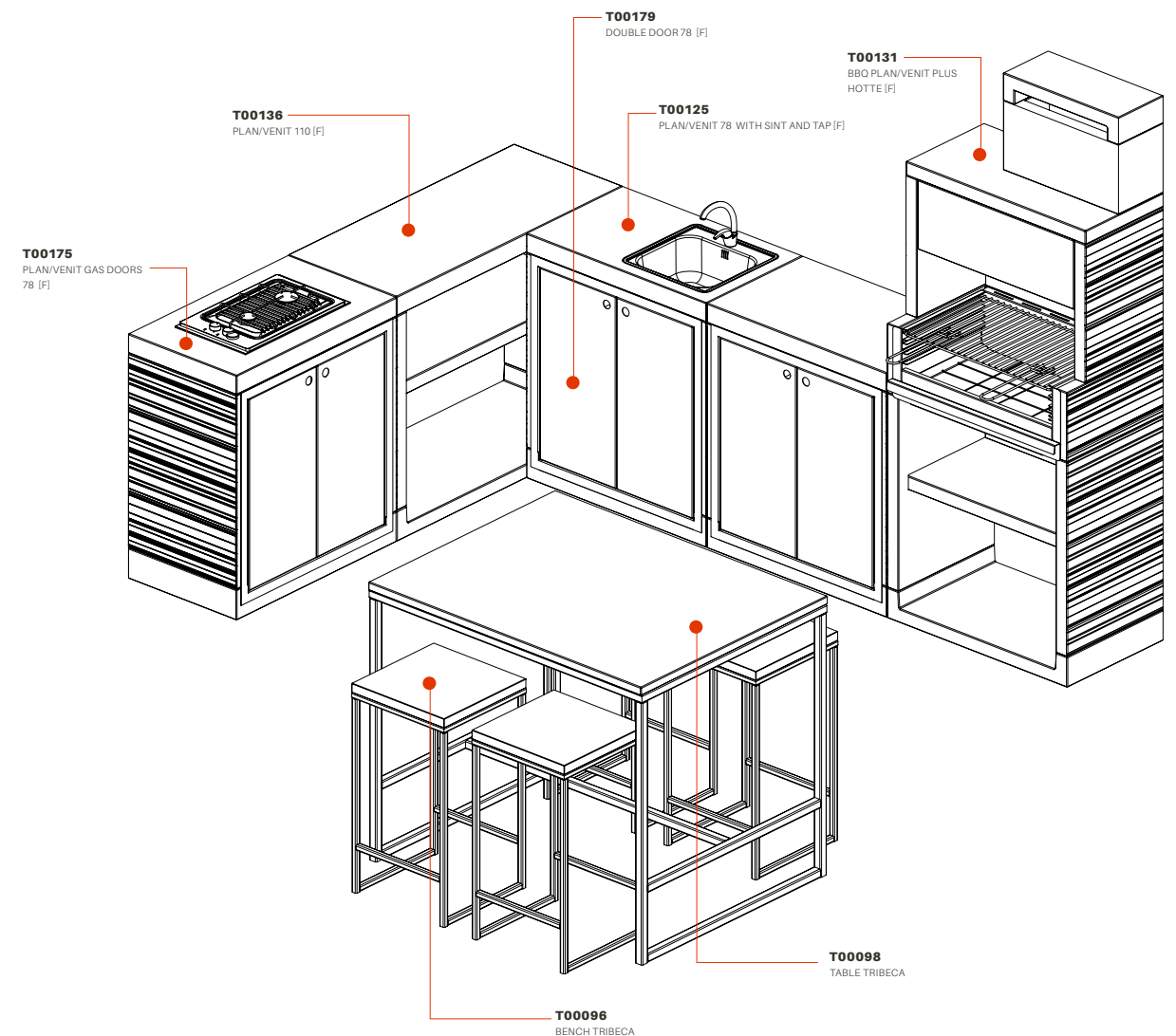

sunny living 

TUOZI Rocket Wood Stove

(individual or in module)

- . Double chamber combustion wood use stove. Extremely fast to reach cooking temperatures.
- . Cook with a pan, wok, plancha and other cooking stove accessories
- . Very low wood consumption
- . Low emissions
- . Can be used with any kind of wood, such as dry garden waste wood or other dry biomass fuel!



T00207
VENIT ROCKET 59 [F]

White and grey concrete
Textured concrete side parts.
Concrete lower shelf.

 59 x 47 x 93h cm

 192 Kg

 Packing dimensions+
80 x 60 x 100h cm
+ package with 2 bbq
on individual pallet units/truck 132

T00208 MODULE WITH BLACK ROCKET

T00180
VENIT ROCKET 59

White and grey concrete
Textured concrete side parts.
Concrete lower

 59 x 47 x 77h cm

 145 Kg

 Packing dimensions+
80 x 60 x 100h cm
+ package with 2 bbq
on individual pallet units/truck 132

T00206 MODULE WITH BLACK ROCKET



T00181
TUOZI ROCKET S
304 Stainless Steel

T00182
TUOZI ROCKET



[T00206] [T00208] [T00180] [T00207]

The TUOZI Rocket stove is an extremely efficient wood burning stove. It uses up to 50% less wood when compared to traditional wood stoves and reach cooking temperatures extremely fast, with very small quantity of fuel. As fuel, the TUOZI Rocket Stove burns any kind of wood or other natural fuel such as, dry garden waste wood or debris and other dry biomass fuel.

It is extremely practical, and allows to cook any kind of food, in a healthy, economic and environmentally friendly way. It can be used with pans, wok, planchas and other available accessories. It can also be used as an outdoor heater.

Please check for available accessories, and explore all the potential of cooking with the TUOZI Rocket Stove.
Available in Stainless Steel or thermal resistant Powder Coated Steel.



design
innovation



tuozì
by Movelar®

Plan/Venit system

SOME CONFIGURATION

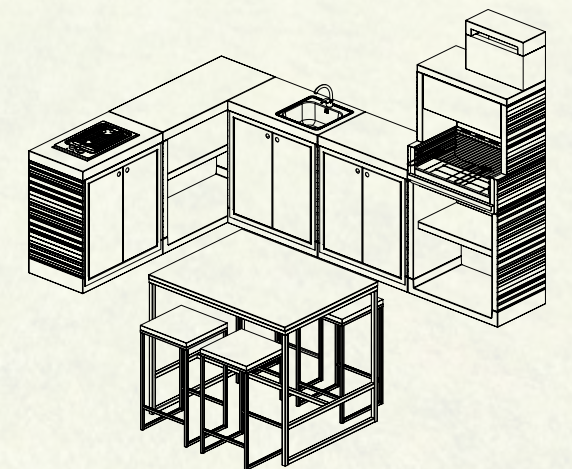
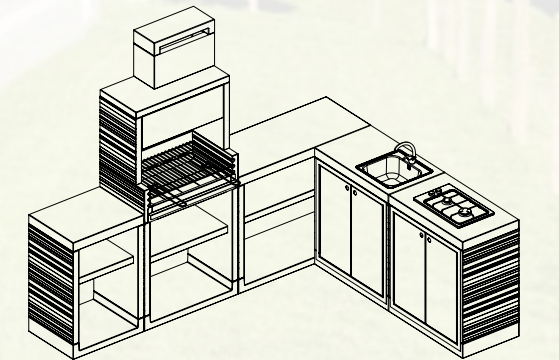
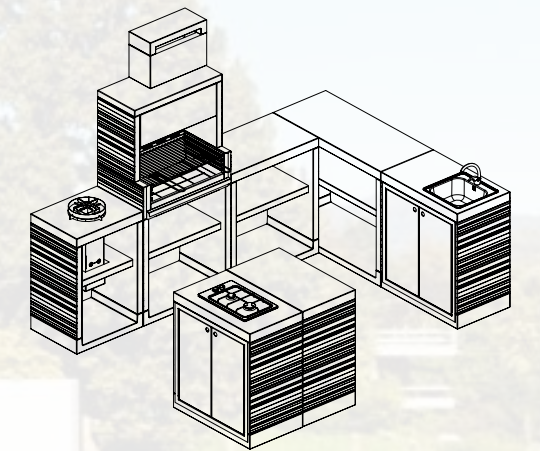
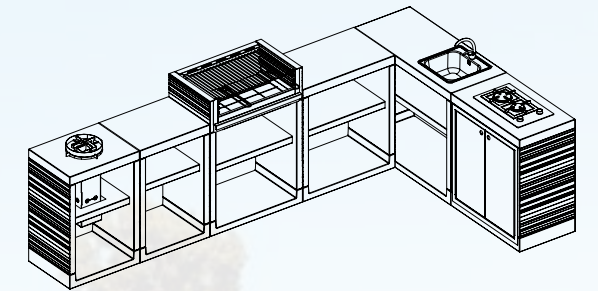

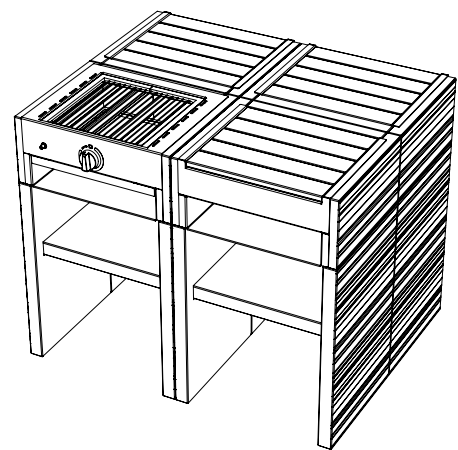

sunny living 



SERIE
PLAN/VENIT
GAS system



Plan/Venit system

SOME PLUS CONFIGURATIONS

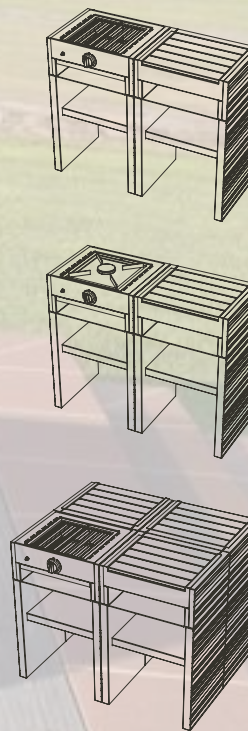

DESCRIPTION

- . White and Grey concrete
- . Works with butane or propane gas
- . Optimized gas burning: 2x 160g/h
- . Grill area from 1200 to 2600cm²
- . Ignition through piezo system
- . 1 x concrete lower shelf

VENIT [GAS]

BARBECUES SYSTEM

COMPATIBLE with all PLAN and VENIT BARBECUES



T00076
PACK 10 VENIT/GAS
GAS SYSTEM

GAS POWER **8,8kw**

Smooth and strip

156 x 47 x 95 cm

56 x 36 cm

335 Kg

Packing dimensions+
00 x 00 x 00h cm
+ package with 2 bbq
on individual pallet

- . Works with butane or propane gas
- . Optimized gas burning: 2x 160g/h
- . Grill area of 2600 cm²
- . Ignition through piezo system
- . 1 x metal concrete lower shelf
- . 1 x concrete lower shelf
- . Power **8,8 w**



8010.8011/1
78 x 47 x 77h cm
110 x 47 x 77h cm

8072
VENIT FLEX 0
GAS SYSTEM

GAS POWER **2,2 kw**

Smooth and strip

59 x 47 x 95cm

155 Kg | 4/5 px

Packing dimensions+
80x70x80h cm
+ package with 2 bbq
on individual pallet

8073
VENIT FLEX 0
GAS SYSTEM

GAS POWER **4,4 kw**

Smooth and strip

59 x 47 x 95cm

35 x 35 cm

155 Kg | 4/5 px

Packing dimensions+
80x70x80h cm
+ package with 2 bbq
on individual pallet

8074
VENIT FLEX 1
GAS SYSTEM

GAS POWER **8,8 kw**

Smooth and strip

78 x 47 x 95h cm

55 x 35 cm

185 Kg | 4/5 px

Packing dimensions+
80x70x80h cm
+ package with 2 bbq
on individual pallet



DESCRIPTION

- . White and Grey concrete
- . Works with butane or propane gas
- . Optimized gas burning: 2x 160g/h
- . Grill area from 1200 to 2600cm²
- . Ignition through piezo system
- . 1 concrete lower shelf

VENIT [GAS] 🔥

BARBECUES SYSTEM

COMPATIBLE with all PLAN and VENIT BARBECUES

[8073+8010]

T00075

PACK 9 VENIT/GAS

GAS SYSTEM

GAS POWER **4,4kw**

Smooth and strip

118 x 47 x 102h cm

36 x 36 cm

275 Kg

- . Works with butane or propane gas
- . Optimized gas burning: 160g/h
- . **Grill area of 1300 cm²**
- . Ignition through piezo system
- . 1 x metal concrete lower shelf
- . 1 x concrete lower shelf
- . Power 4,4 w

Packing dimensions+ **85 x 65 x 130h cm**
+ package with 2 bbq on individual pallet units/truck**112**



8010 PLAN/VENIT 0

White and grey concrete
Textured concrete side parts. Concrete lower shelf

59 x 47 x 77h cm

120 Kg

Packing dimensions+ **80 x 60 x 100h cm**
+ package with 2 bbq on individual pallet units/truck**132**



8011 PLAN/VENIT 1

White and grey concrete
Textured concrete side parts. Concrete lower shelf

78 x 47 x 77h cm

150 Kg

Packing dimensions+ **80 x 60 x 100h cm**
+ package with 2 bbq on individual pallet units/truck**132**



8012 PLAN/VENIT 2

White and grey concrete
Textured concrete side parts. Concrete lower shelf

110 x 47 x 77h cm

199 Kg

Packing dimensions+ **120 x 80 x 100h cm**
+ package with 2 bbq on individual pallet units/truck**66**



8011/1 . 8012/1 PLAN/VENIT 1 PLAN/VENIT SINK/TAP

White and grey concrete
Textured concrete side parts. Concrete lower shelf

78 x 47 x 77h cm

110 x 47 x 77h cm

150/199 Kg

Packing dimensions+ **85 x 65 x 130h cm**
+ package with 2 bbq on individual pallet units/truck**112**



Plan/Venit system
SOME PLUS CONFIGURATIONS

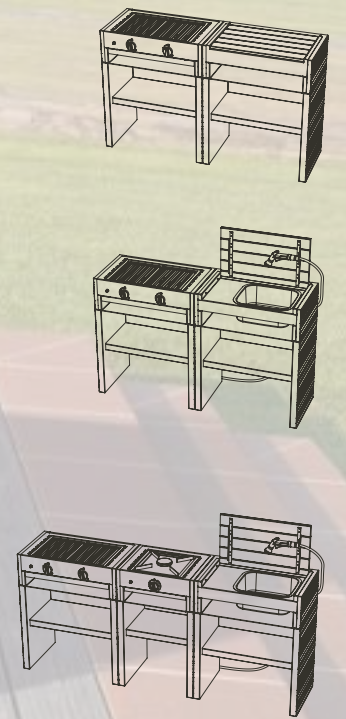

- DESCRIPTION
- . White and Grey concrete
 - . Works with butane or propane gas
 - . Optimized gas burning: 2x 160g/h
 - . Grill area from 1200 to 2600cm²
 - . Ignition through piezo system
 - . 1 x concrete lower shelf







MODULES [GÁS]

system





PACK VENIT/GAS

GAS SYSTEM

-  GAS POWER **4,4kw**
- Smooth and strip
-  **118 x 47 x 102 cm**
-  **36 x 36 cm**
-  **310 Kg**  **4/5 px**
-  Packing dimensions+ **85 x 65 x 130h cm**
+ package with 2 bbsq on individual pallet units/truck **112**
- . Works with butane or propane gas
- . Optimized gas burning: 160g/h
- . Grill area of 1269 cm²
- . Ignition through piezo system
- . 1 x metal concrete lower shelf
- . 1 x concrete lower shelf
- . Power 4,4 w
- . **DOUBLE FUNCTION (ALTERNATE):** full working surface and washing area
- . Metal lower shelf
- . Concrete lower shelf





8068
VENIT FLEX O
GAS SYSTEM MODULE

-  MODULE GAS
- Smooth and strip
-  **59 x 47 x 95h cm**
-  **155 Kg**







 Packing dimensions+ **80x70x60h cm**
+ package with 2 bbsq on individual pallet units/truck **112**

8068/1
VENIT FLEX O
GAS SYSTEM MODULE

-  MODULE GAS
- Smooth and strip
-  **59 x 47 x 95 h cm**
-  **155 Kg**

 Packing dimensions+ **80x70x60h cm**
+ package with 2 bbsq on individual pallet units/truck **112**

8068+8068/1+8073
PACK GAS VENIT
GAS SYSTEM

-  GAS POWER **4,4 kw**
- Smooth and strip
-  **118 x 94 x 95h cm**
-  **36 x 36 cm**
-  **620 Kg**  **4/5 px**
-  Packing dimensions+ **80x70x60h cm**
+ package with 2 bbsq on individual pallet units/truck **112**
- . Works with butane or propane gas
- . Optimized gas burning: 160g/h
- . Grill area of 1300 cm²
- . Ignition through piezo system
- . 1 x concrete lower shelf
- . **Power 4,4 w**
- . Garden Hose NOT INCLUDED



Plan/Venit system

SOME PLUS CONFIGURATIONS

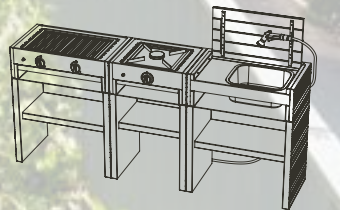
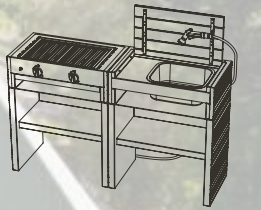
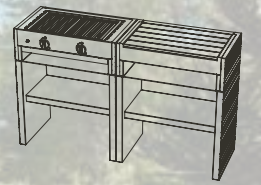

DESCRIPTION

- . White and Grey concrete
- . Works with butane or propane gas
- . Optimized gas burning: 2x 160g/h
- . Grill area from 1200 to 2600cm²
- . Ignition through piezo system
- . 1 x metal concrete lower shelf
- . 1 x concrete lower shelf



[8074+8069/1]

T00077
PACK 13 VENIT/GAS
GAS SYSTEM

- GAS POWER **8,8kw**
- Smooth and strip
- 156 x 47 x 95 cm**
- 56 x 36 cm**
- 365 Kg**

- . Works with butane or propane gas
- . Optimized gas burning: 2x 160g/h
- . Grill area of 2600 cm²
- . Ignition through piezo system
- . 1 x concrete lower shelf
- . Power 8,8 w
- . **DOUBLE FUNCTION (ALTERNATE):** full working surface and washing area
- . Metal lower shelf
- . Concrete lower shelf
- . Garden hose NOT INCLUDED

Packing dimensions+ **85 x 65 x 130h cm**
+ package with 2 bbq on individual pallet units/truck **112**



8069
VENIT FLEX 1
GAS SYSTEM MODULE

- MODULE GAS
- Smooth and strip
- 78 x 47 x 95h cm**
- 180 Kg**

Packing dimensions+ **80x70x60h cm**
+ package with 2 bbq on individual pallet units/truck

8069/1
VENIT FLEX 1
GAS SYSTEM MODULE

- MODULE GAS
- Smooth and strip
- 78 x 47 x 95h cm**
- 180 Kg**

Packing dimensions+ **80x70x60h cm**
+ package with 2 bbq on individual pallet units/truck

8069/1+8073+8074
PACK GAS VENIT
GAS SYSTEM

- GAS POWER **2,2/8,8kw**
- Smooth and strip
- 215 x 47 x 95h cm**
- 56 x 36 cm**
- 510 Kg** **10 px**

Packing dimensions+ units/truck
+ package with 2 bbq on individual pallet

- . Works with butane or propane gas
- . Optimized gas burning: 160g/h
- . Power: **8,8 kW**
- . Grill area of 1300 cm²
- . Power: **2.2 kW**
- . Area of the grid: 1,300 cm²
- . Ignition through Piezo system
- . Bottom metal stand
- . Ignition through piezo system
- . Metal concrete lower shelf
- . Concrete lower shelf

. Garden Hose NOT INCLUDED

www.tuozi.pt | www.movelar.pt

Zona Industrial de Porto de Mós
Rua principal | Lote 17 - C
2480-407 Porto de Mós
Portugal

tel: +351 244 481 036
fax: +351 244 482 003

info@tuozi.pt

co-financiamento:

